

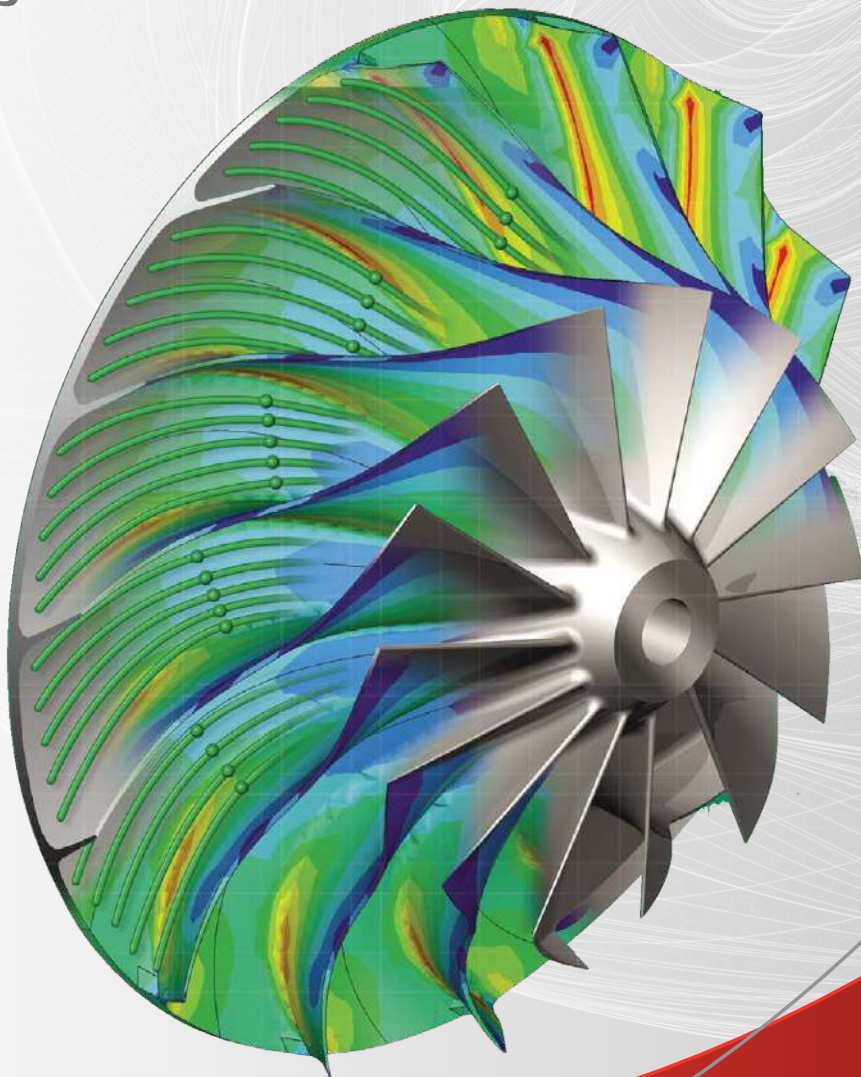

# *Engineered Air, Industrial and Process Gas Centrifugal Compressors*

**MSG<sup>®</sup> and MSG<sup>®</sup> TURBO-AIR<sup>®</sup> Series  
featuring oil-free air**

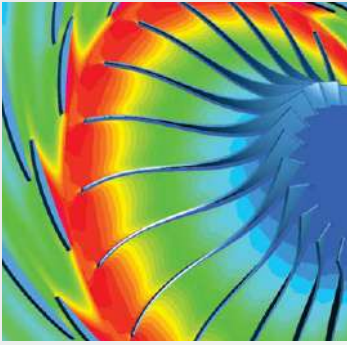



**You have many distinct advantages when you partner with Ingersoll Rand for your centrifugal compressor needs.**

Ingersoll Rand manufactures centrifugal air and gas compressors and provides aftermarket products and services for a broad customer base around the world. The cutting-edge solutions we deliver for air, industrial and process gas requirements are made possible by the unique blend of product quality, engineering talent and dedicated teamwork brought to every customer.

# CENTRIFUGAL COMPRESSORS

With our main manufacturing facility in Buffalo, N.Y., and distribution in more than 80 sales and service locations worldwide, Ingersoll Rand is a global company with a commitment to meeting your needs with exceptional centrifugal compressor technology while exceeding your expectations with unequalled service and support.

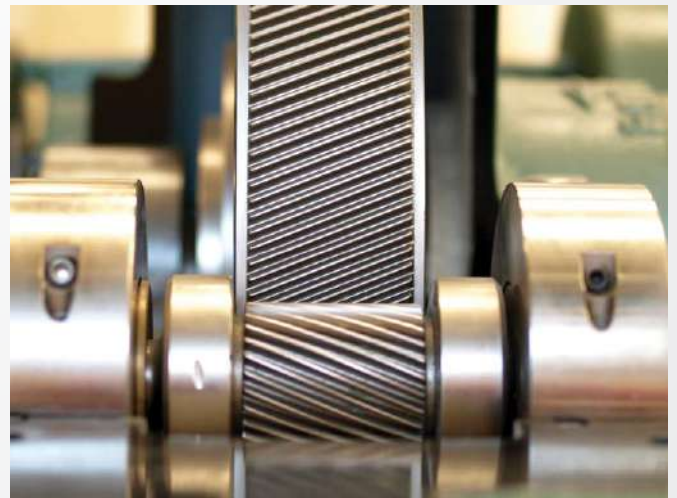



# MSG® and MSG® TURBO-AIR® Integrally Geared Centrifugal Compressors

MSG (multi-stage geared) and MSG TURBO-AIR compressors offer outstanding design flexibility. MSG compressors are application engineered with numerous available configurations:

- Flows from 70 to 3800 m<sup>3</sup>/min (2500 to 135,000 CFM)
- Input capacity to over 18,650 kW (25,000 hp)
- Discharge pressures to 100 barg (1450 psig)

MSG TURBO-AIR engineered compressors are completely packaged on a common base for easy installation and are available in a number of configurations:

- Flows from 14 to 430 m<sup>3</sup>/min (500 to 15,200 CFM)
- Horsepower capacity to more than 3355 kW (4500 hp)
- Discharge pressures to 42 barg (610 psig)



## A HISTORY OF INNOVATION







- 1955** Joy Manufacturing Co. established facility in Buffalo, N.Y.
- 1960** First small integrally geared centrifugal compressor introduced
- 1965** First packaged centrifugal compressor introduced
- 1971** First four-stage, nitrogen recycling machine for liquefaction of industrial gases
- 1980** First microprocessor-controlled compressor launched
- 1987** Purchased by Cooper Industries, Inc. – major capital investments made
- 1988** First seven-stage, dual-service machine with three pinions in each gearbox
- 1994** MSG TURBO-AIR 2000 introduced, incorporating the fourth generation of microprocessor-based control
- 1995** Cooper Cameron Corporation established
- 1997** MSG TURBO-AIR 3000 introduced – major capital investments made
- 1999** MSG TURBO-AIR 6000 introduced
- 2001** MSG TURBO-AIR COOLED™ 2000 introduced  
Entered process gas market  
Introduced TURBO DryPak™
- 2004** MAESTRO™ series of compressor control systems introduced
- 2008** MSG TURBO-AIR high-pressure series introduced
- 2009** MSG-18 introduced  
TURBO-GAS™ 2040 introduced  
Class Zero Certification awarded
- 2010** MSG TURBO-AIR 6040 introduced
- 2013** MSG TURBO-AIR NX 12000 introduced
- 2015** Cameron's Centrifugal Compression division acquired by Ingersoll Rand  
MSG TURBO-AIR NX 8000 introduced

# The Advantages of Centrifugal Compressor Technology

Integrally geared centrifugal compressors represent the latest technology, offering significant advantages over outdated, less-efficient and more costly compressor designs. These advantages are inherent in the centrifugal design and are further enhanced by Ingersoll Rand's more than 60 years of centrifugal expertise.



Compare the innovative technology of MSG and MSG TURBO-AIR centrifugal compressors with other machines, such as positive displacement compressors, and the advantages are clear.

	MSG AND MSG TURBO-AIR CENTRIFUGAL COMPRESSORS	OTHER COMPRESSORS
<p><b>LOW MAINTENANCE</b></p> 	<ul style="list-style-type: none"> <li>• Compression elements do not wear or require periodic replacement</li> <li>• Oil filter elements and seal gas filter elements are easily replaced online</li> <li>• Bearings designed for extended life</li> </ul>	<ul style="list-style-type: none"> <li>• Require regular maintenance, such as replacement of piston rings, gland packing and valve plates, or periodic replacement of air ends</li> <li>• Result in high operating expenses and significant machine downtime</li> </ul>
<p><b>OIL-FREE PROCESS GAS</b></p> 	<ul style="list-style-type: none"> <li>• 100% oil-free per ISO 8573-1 certification</li> <li>• Prevent contamination of system</li> <li>• Meet strict downstream requirements</li> </ul>	<ul style="list-style-type: none"> <li>• Oil filters must be installed at discharge</li> <li>• Potential for oil carryover to foul the process</li> <li>• Oil free claim is based dependent on uninterrupted seal gas supply</li> </ul>
<p><b>HIGH RELIABILITY</b></p> 	<ul style="list-style-type: none"> <li>• Centrifugal compressors are proven to have a long mean time between failures (MTBF), and independent research has shown an industry-leading availability of 99.7%</li> <li>• Conservative, high-quality gear design</li> </ul>	<ul style="list-style-type: none"> <li>• Contacting compression elements are subject to wear</li> <li>• Limited rotating element life</li> <li>• Designed-in wearing items to generate aftermarket revenues</li> </ul>
<p><b>NO PULSATION</b></p> 	<ul style="list-style-type: none"> <li>• Pulsation-free and require no dampers</li> </ul>	<ul style="list-style-type: none"> <li>• Require the use of large pulsation dampers to reduce pressure fluctuations</li> </ul>
<p><b>OPTIMUM CONTROL</b></p> 	<ul style="list-style-type: none"> <li>• Feature inlet guide vane control plus bypass for consistent gas delivery</li> <li>• Automatic operation and precision control for most operating conditions</li> <li>• State-of-the-art MAESTRO-suite of controls</li> <li>• PLC control systems available</li> </ul>	<ul style="list-style-type: none"> <li>• The use of cylinder unloading for stepped flow control can result in complicated process control due to sudden changes in capacity</li> </ul>
<p><b>COMPACT INSTALLATION FOOTPRINT</b></p> 	<ul style="list-style-type: none"> <li>• Capable of handling substantially higher volumes of gas in one or two small casings for a smaller overall package</li> </ul>	<ul style="list-style-type: none"> <li>• May have four or six cylinders requiring more space for installation</li> </ul>
<p><b>NO VIBRATION</b></p> 	<ul style="list-style-type: none"> <li>• Essentially vibration-free</li> <li>• Require only a pad suitable for supporting the static weight of the package</li> </ul>	<ul style="list-style-type: none"> <li>• Require large and deep foundation to handle heavy weight and unbalanced forces</li> <li>• Precautions must be taken to prevent transmission of vibration to other equipment</li> </ul>



## VARIABLE INLET GUIDE VANES



- Optional variable inlet guide vanes can offer power savings of up to 9% when operating in turndown
- Inlet guide vanes impart a whirling motion to the inlet air flow in the same direction as the impeller operation, reducing the work input
- Net power savings can be realized at reduced flow or on days colder than the design temperature
- Inlet guide vanes are positioned close to the inducer of the impeller to maximize performance
- Throttling capabilities allow for start-up in high-static load situations

## Oil-free Air and Gas

- Prevents system contamination
- Reduces the potential for compressed air pipeline fires caused by oil carryover
- No costly waste disposal associated with oil-laden condensate
- Eliminates the expense and maintenance of oil separation filters at the discharge

## High Reliability

MSG and MSG TURBO-AIR centrifugal compressors are designed to be extremely reliable due to:

- Conservative high-quality gear design
- Long-life pinion bearing design
- Thrust loads absorbed at low speed
- Stainless steel compression elements

## Low Compressor Operating Life Cycle Cost

MSG and MSG TURBO-AIR centrifugal compressors provide better overall operating efficiency than positive displacement or other centrifugal compressors.

- Excellent efficiencies at full load, part load and no load
- Low maintenance cost
- Increased uptime from high-reliability design (limits the need for multiple unit installations for basic reliability reasons)
- No sliding or rubbing parts in the compression process that can cause wear and thereby efficiency loss

## Easy Operation/Maintenance

- State-of-the-art MAESTRO control systems
- Fully automated operation for any process conditions
- Machine self-diagnostics
- Compression elements do not wear or require periodic replacement
- Accessible horizontally split gearbox for quick inspection
- Removable intercooler and aftercooler bundles for easy cleaning

## Simple Installation

- Compressor, lubrication system, intercoolers, shaft coupling, coupling guard, interconnecting piping, etc. on a common base
- Easy installation with no special foundation requirements
- Easy component accessibility
- Site connection point flexibility
- Reduced floor space required
- Dynamic compression process is pulsation-free, so installation of additional dampening equipment is not required.

# The Right Compressor for Your Needs

In a wide variety of applications, there is an MSG or MSG TURBO-AIR centrifugal compressor that meets your requirements. With more than 14,000 installations worldwide, on nearly every continent, Ingersoll Rand's products are proven in a number of different industries.



## **3R2MSGPB-5G/30** Gas Compressor (left)

APPLICATION: Located in Algeria;  
used as a propane boil-off gas compressor

SPECIFICATIONS: Flow = 20,000 kg/h  
Discharge Pressure = 7.3 barA

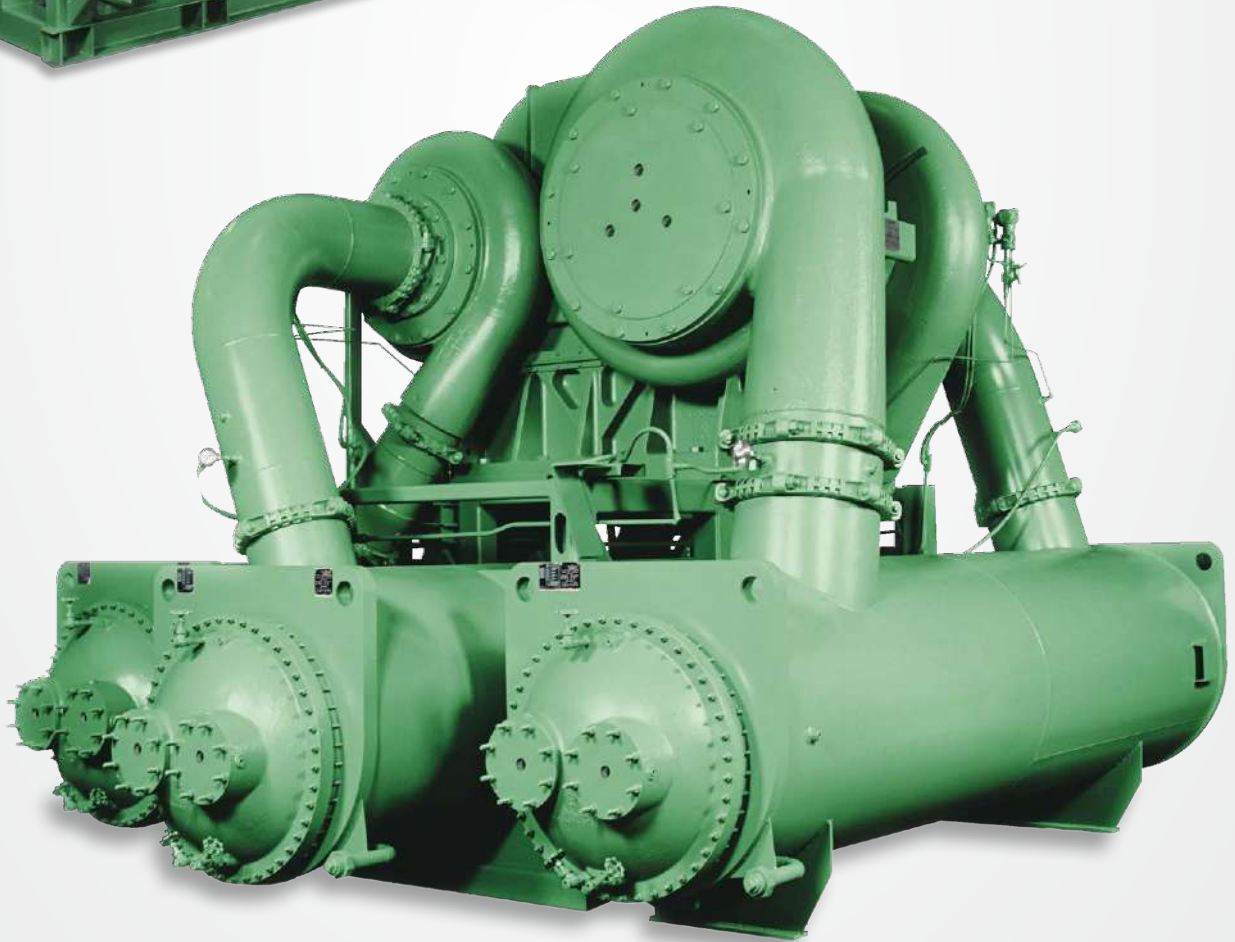

## **4MSG-16/15** Air Compressor (below)

APPLICATION: Located in China;  
used as a main air compressor (MAC)  
for an air separation plant

SPECIFICATIONS: Flow = 59,000 Nm<sup>3</sup>/h  
Discharge Pressure = 12.4 barA



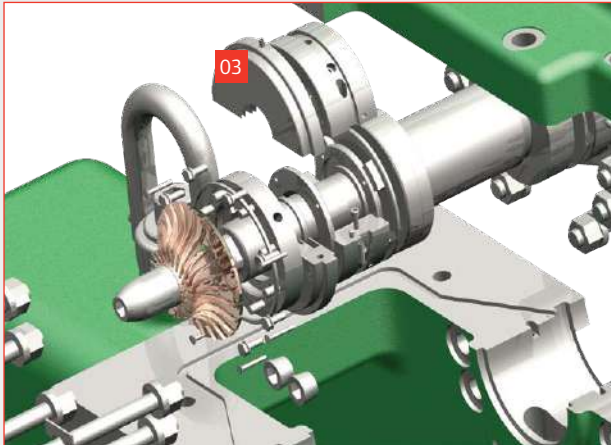

### Engineered Air Applications

- Industrial gases
- Instrument air
- American Petroleum Institute (API) standards
- Soot blowers
- Large plant air
- Power industry related

### Gas Compressor Applications

- Fuel gas boosting
- Natural gas gathering
- Hydrocarbon refrigeration gas
- Carbon monoxide
- CO<sub>2</sub> (wet or dry)
- SynGas
- Low molecular weight recycle gas
- High-pressure nitrogen
- Landfill gas

### MSG and MSG TURBO-AIR centrifugal compressors are exceptional by design.

- One, two or three rotors, up to six stages per gearbox
- Horizontal splitline(s) for easy access to parts

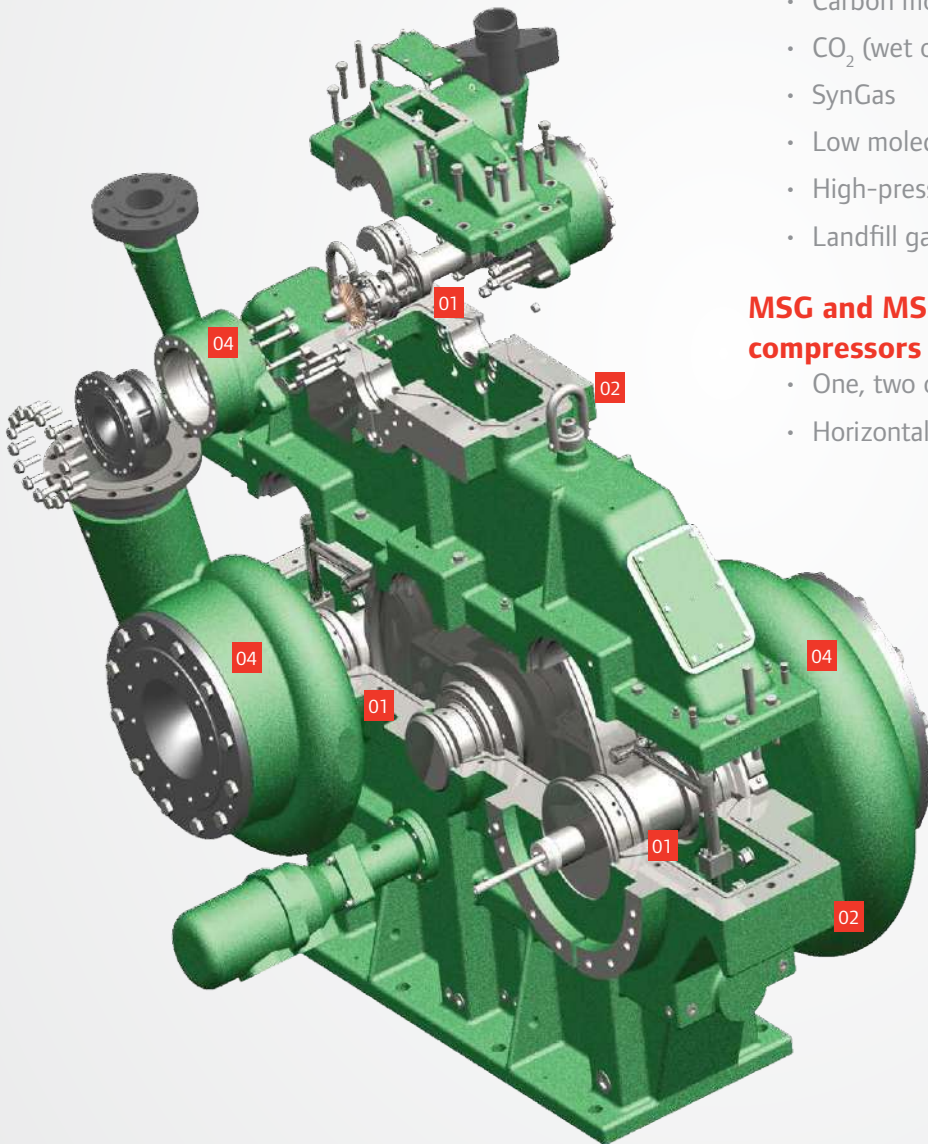

#### Cross-sectional View of a Typical Three-rotor Process Gas Compressor

- 01: One, two or three rotors, up to six stages per gearbox
- 02: Horizontal splitline(s) for easy access to parts
- 03: Engineered seal designs
- 04: NACE-compliant scrolls and inlets can be manufactured from steel or stainless steel



## Horizontally Split Gearbox for Easy Maintenance

- Allows inspection or replacement of gears, bearings and oil seals by simply lifting a cover
- No disassembly of piping or heat exchangers is necessary
- Periodic inspections and maintenance are made easy
- Reduced maintenance, increased uptime

## Bullgears for Optimum Speed and Efficiency

- Allows each pinion to operate at optimum speed, as determined by the flow and efficiency characteristics of the impeller
- Main driver is connected directly to the compressor by a low-speed coupling
- Gears are high-speed, precision helical-type, designed to meet or exceed AGMA and ISO quality standards



Five-pad Tilting Pad Bearing Assembly

## Tilting Pad Pinion Bearings for High Reliability

- Five-pad Tilting Pad bearings have the highest stability and lowest vibration level for high-speed shafts, which are subjected to variable loading over a wide range
- High reliability over the entire operating range, from full load to no load
- Pressure-lubricated and steel-backed for increased reliability

## Rotor Assembly for Smooth Operation

- Each rotor assembly consists of a pinion shaft, to which one or two impellers are attached
- Pinion gears are hardened and precision-ground (AGMA and ISO quality) for longer life
- Smooth, vibration-free operation is assured through precision balancing

## Tapered Rider Ring Thrust Collars on the Pinion Shaft

- Centrifugal design mitigates the majority of power-robbing thrust loads
- Thrust collars on pinion shaft create an oil wedge, which carries the small remaining net thrust to the bullgear where it is absorbed by a simple low-speed thrust bearing
- Reduces gearbox power losses while increasing mechanical integrity

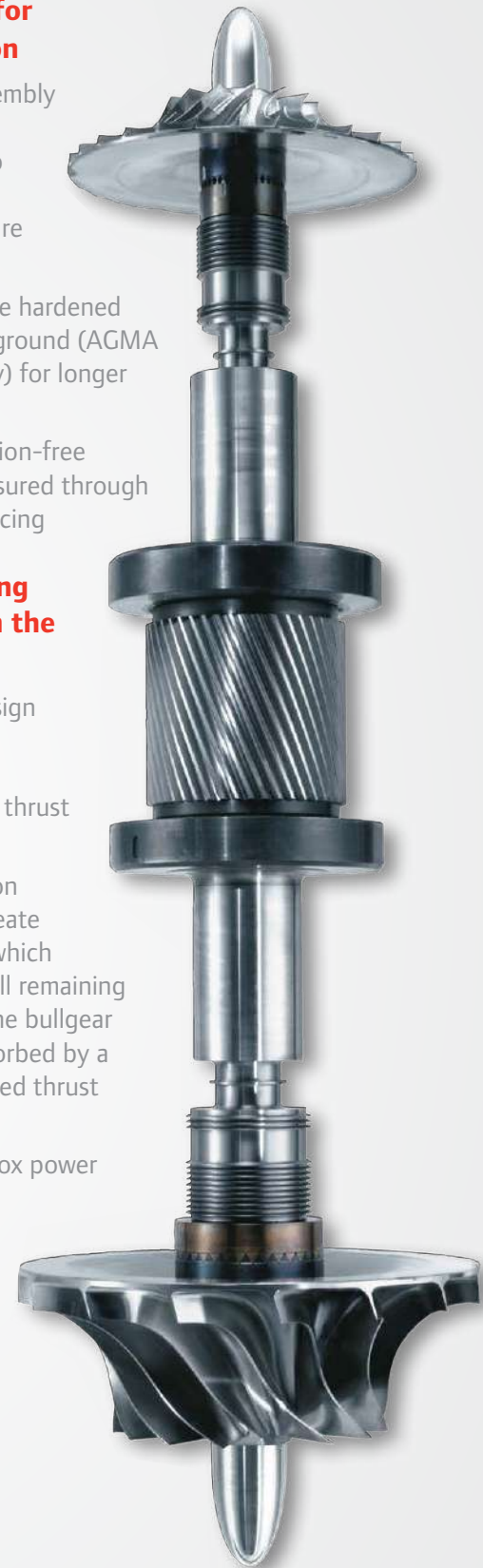

# Seal Design Options

Ingersoll Rand offers a complete range of seal arrangements to meet the specific needs of your application.

## Standard Labyrinth-style Air/Gas and Oil Seals

- Used with atmospheric air and low-pressure gases
- Effectively confine air in the stage casings and prevent contamination of the gas stream from lubricating oil
- Non-contacting seals eliminate shaft wear
- Do not require periodic replacement
- Only require inspection every five to six years under normal operating conditions



**Babbitted Air Seal**

## Babbitted-style Air/Gas Seals

- Used with high-pressure and nitrogen applications
  - When used with educting, these seals have an excellent recovery rate
  - Knife edges on pinion cut into the babbitt material on seal for closer fit and very low leakage
  - Babbitt material has a high tin content for lubricity
  - Seal maintenance is not required for five to six years under normal use
- Ports can be machined in the seal to recover process gas or buffer the seal during periods of non-use

**Labyrinth Oil Seal**



## Carbon Ring Seals

- Designed with two solid, floating carbon rings with close shaft clearance
- Non-contacting seal, so periodic maintenance is not required under normal usage
- Complete assembly bolts inside the scroll and is accessed by removing the impeller
- Leakage control is significantly better than the babbitt seal for the same pressure

## Single Dry-face Seal

- Used on hydrocarbon and process gases where leakage is not allowed, or on high-pressure applications where labyrinth seals cannot provide enough leakage protection
- Seal system is completely oil-free
- Buffer gas pressure can be set so that no buffer gas enters the process and a small amount of process gas vents out of the system

## Other Types of Seals

- Tandem seal with buffered backup seal
- Oil bushing seal with separate seal oil system



**Labyrinth Air Seal**



## Gas Seal Options for Your Process Applications

Multiple gas seal designs are available for a wide range of process gases and leakage requirements. Ingersoll Rand can suggest a seal type based on your process, or we can design the seal of your choice – all major seal suppliers can be used.

Ingersoll Rand’s standard dry-face seal uses a floating self-centering rider. The clearance fit allows the seal to be removed easily and installed without puller tools. The seal comes as a complete assembly with an installation plate.

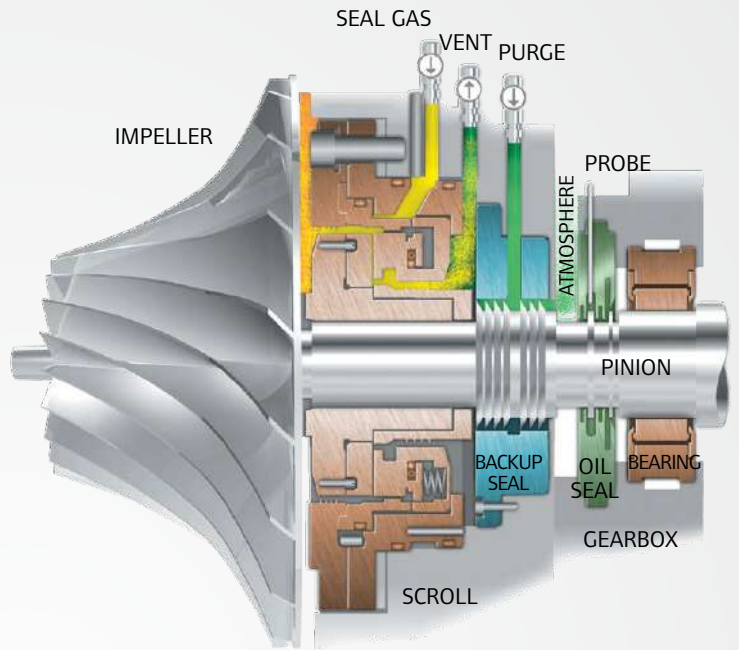

Single dry-face seal with a babbitted backup

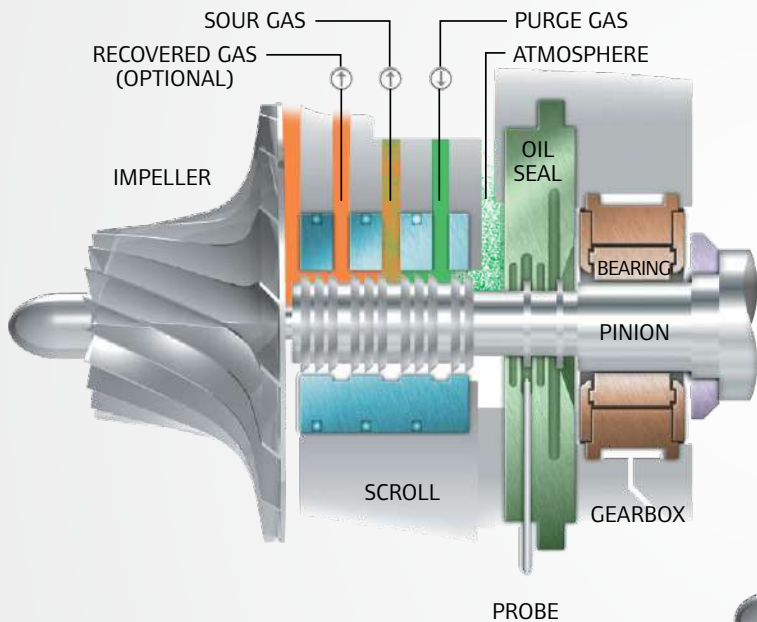

Multiport babbitted seal with purge

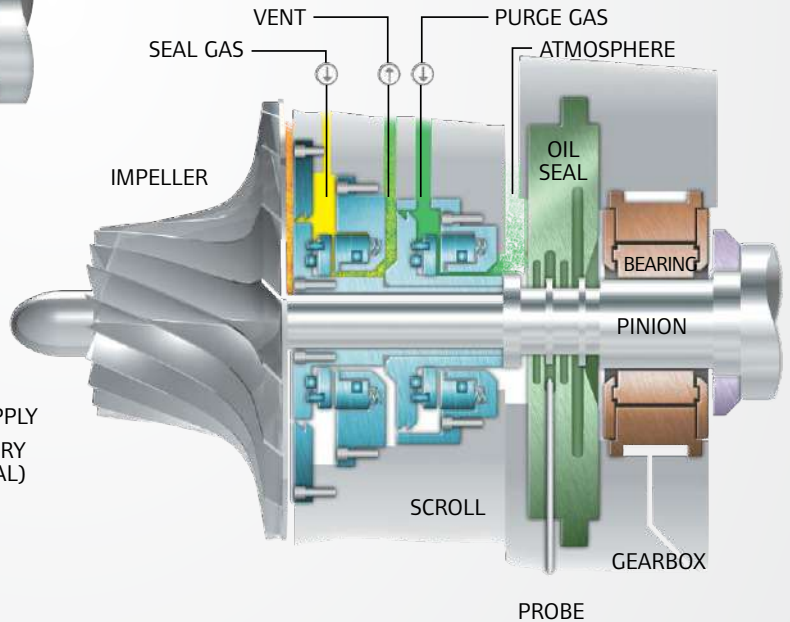

Tandem dry-face seal with integral labyrinth

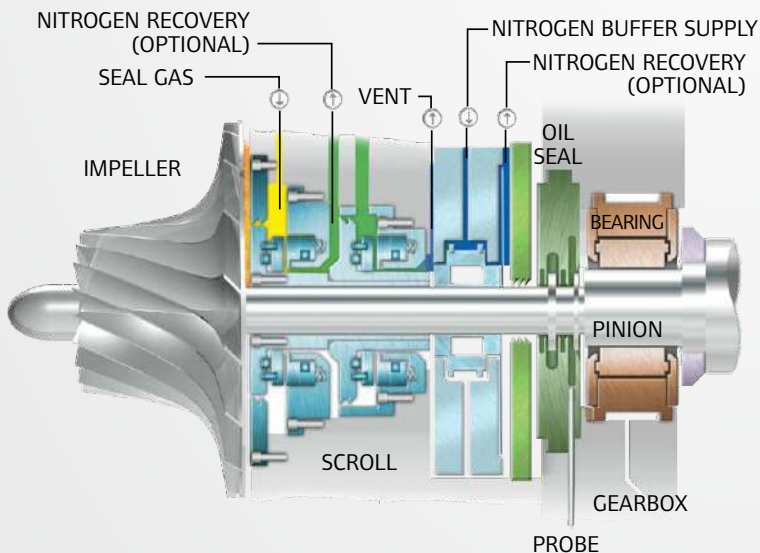

Tandem dry-face seal with carbon ring back-up

# Process Gas Seal Support

Gas seal support systems are designed, built and tested per API 614. System designs can be based on differential pressure control, flow control or other control methods. The scope of supply is virtually unlimited and fully automatic. Manual or customer-specified systems can be engineered for most gas seal types.

Systems are designed with instrumentation to monitor seal condition. Filters and accessories are supplied with sufficient instruments to plan maintenance and reduce downtime. The goal is to save you time and money by providing worry-free operation of your equipment with simple maintenance.



Gas seal transmitter rack with 2-of-3 voting, seal gas filtering and purge gas filtering

## Aerodynamic Performance

### Unique Impeller Designs

Impellers, diffusers and scrolls are uniquely designed to meet your specific needs. Examples of our impellers include:

### Custom Engineered/Five-axis Milled

- Custom-designed using computational fluid dynamics (CFD) for aerodynamic design and finite element analysis (FEA) for mechanical integrity
- Optimized designs for custom applications
- Overall savings can be as great as a 5% increase in efficiency over some cast impeller designs



Fuel gas booster skid with scrubber, bypass and recirculation piping



# Control Systems

Ingersoll Rand can provide the right control system engineered for your applications.

## MAESTRO Suite of Controls

The MAESTRO suite of compressor control systems offers optimal protection and control for your compressor system, and is likely to contain a model that is sure to be in tune with your needs.

### MAESTRO Universal

- Windows CE-driven system includes a built-in web server and setup wizard for quick configuration
- Able to handle multiple stages and is designed for many makes and models of compressors
- 10" color graphic display provides easy monitoring
- Built-in USB port for system configuration and data logging
- Capable of monitoring and controlling the total system across multiple units

### MAESTRO PLC

- Utilizes an open-architecture Allen Bradley PLC which enables you to use off-the-shelf components that match other panels in your plant
- Available in three control methods: constant pressure, auto/dual and mass flow
- Siemens PLC platform is available as an alternative

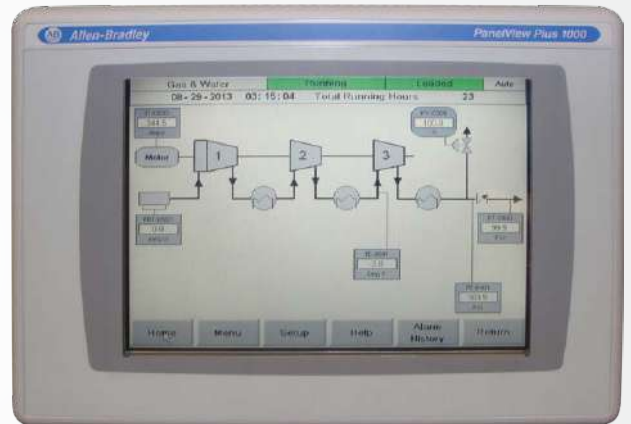

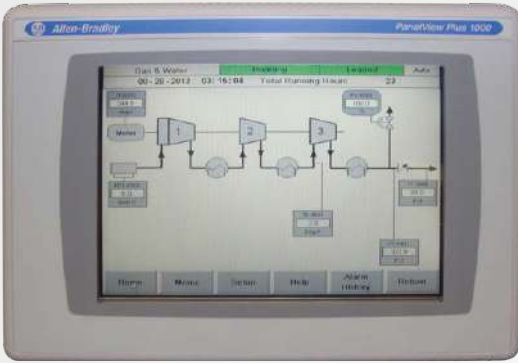

Allen Bradley PLC-based control center with PanelView Plus 1000 interface

## Customized MAESTRO PLC-based Controls

### Customer-defined PLC Controls

PLC-based systems are used for packages with high input/output (I/O) counts, multiple gas circuit control loops and multiple processes. PLCs by all major industrial suppliers are available. Ingersoll Rand can design, program and supply your specified PLC system mounted and wired to any compressor package.

- PLC system is fully tested by our Control Systems Engineering department before shipping
- Logic diagrams and programming software are standard
- Control systems can be locally mounted on the skid, designed with local I/O and remote processors, or any buyer-defined arrangement
- Control system enclosures and wiring are available for US and IEC applications, Class 2 / Zone 2 and non-hazardous installations

## Gas Flow Arrangement

MSG and MSG TURBO-AIR centrifugal compressors feature an advanced arrangement of gas flow components. Advantages of this arrangement include:

- Directed gas movement to reduce turbulence-induced friction
- Air is cooled after every stage to provide high isothermal efficiency

### Air Flow Diagram

- 01: Compressor inlet
- 02: First-stage compressor volute
- 03: Coolant in
- 04: Coolant out
- 05: First-stage intercooler
- 06: Second-stage compressor volute
- 07: Second-stage intercooler
- 08: Third-stage compressor volute
- 09: Compressor discharge

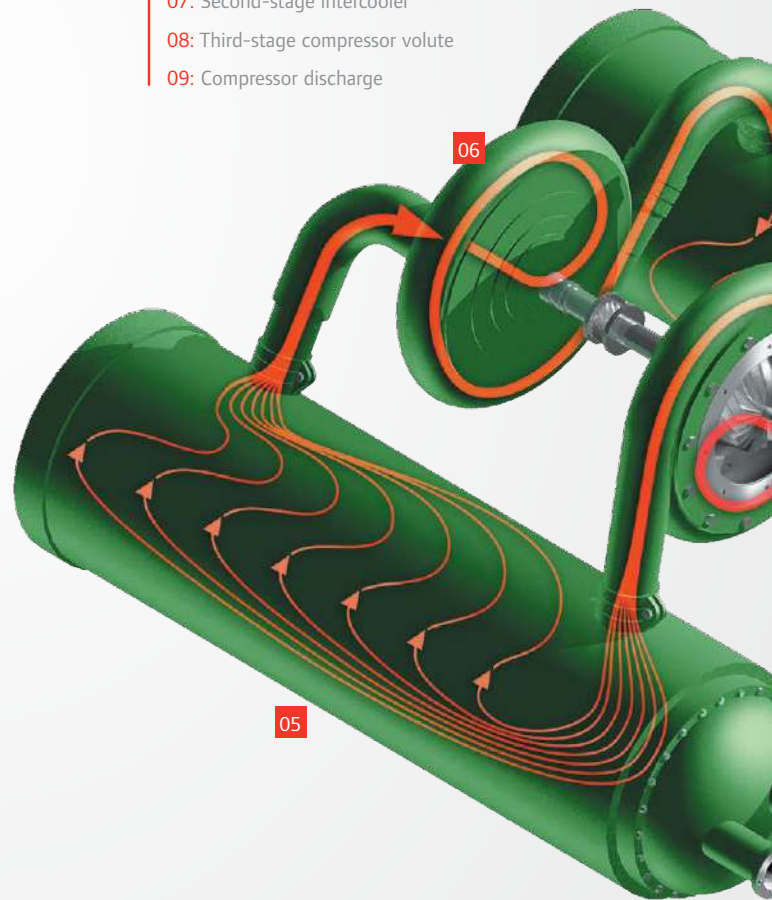



## Packaging Concept

Ingersoll Rand's cutting-edge packaging concept gives you great flexibility to tailor a centrifugal compressor to meet your needs while simplifying installation and maintenance. Our MSG and TURBO-AIR packages can include:

- Lubrication system
- Intercoolers
- Shaft coupling with guard
- Interstage piping
- Main driver
- Control panel

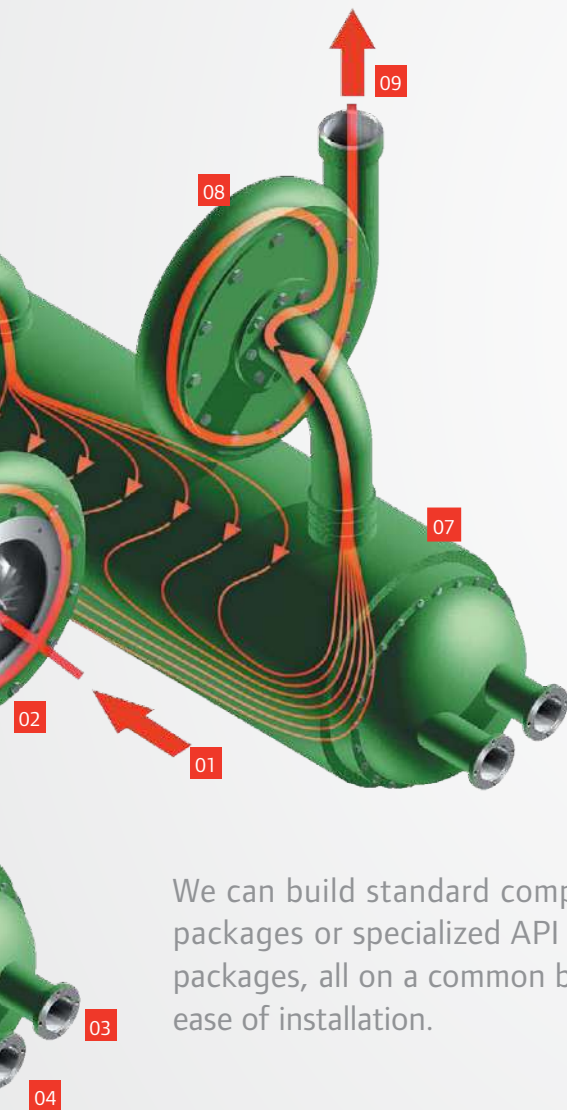

We can build standard compressor packages or specialized API 672/API 617 packages, all on a common baseplate for ease of installation.

## Advanced Lubrication System

Ingersoll Rand's standard self-contained, low-pressure lubrication system:

- Includes an oil reservoir, mechanical oil pump, electric full-flow auxiliary oil pump, fixed-bundle oil cooler, single full-flow oil filter, safety devices and instrumentation for safe compressor operation
- Assembled and packaged on a compressor base when compressor layout permits
- Sized to serve the main driver
- Can be designed to meet:
  - Custom specifications
  - API 672 (packaged centrifugal)
  - API 617 (centrifugal process gas compressor)
  - API 614 (lubrication system)
  - Process Industry Procedures (PIP)
- Interconnecting piping between the lubrication system and compressor when compressor, intercooler(s) and main oil pump arrangement permits

## Intercoolers Guarantee Increased Heat Transfer

Our ASME-coded intercoolers (PED, China Code Pressure Vessel Certification, GOST, KOSHA, and others, as required) provide efficient cooling between stages and are designed to be accessible for inspection and cleaning.

- Water-in-tube cooler designs allow for easy cleaning in areas with poor water conditions
- Extended-surface, plate-fin design provides increased heat transfer with reduced space requirements
- Accessible, smooth-bore tubes are easily rodded with bundles in place
- No disassembly of any other part of the compressor is necessary to perform maintenance



# Excellence in Engineering

From air separation, to plant air, to a variety of process gas applications, Ingersoll Rand's engineers have a broad range of experience in designing systems for customers around the world.

Our teams of engineers and technicians are continually adding to our experience base in a wide variety of applications. These professionals face varying challenges in all compression applications and strive to deliver the best solution every time.

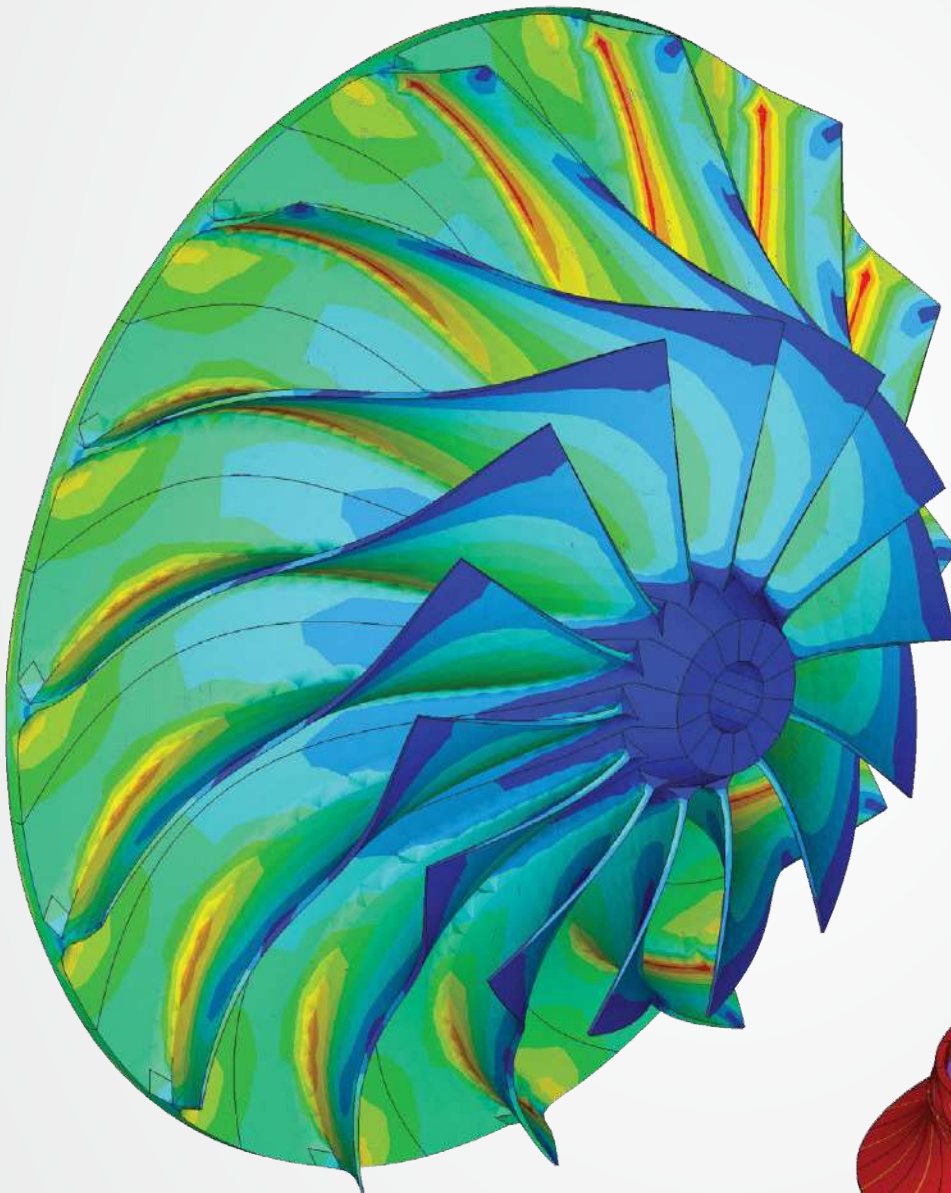

### Impeller Stress Analysis (left)

All five-axis impellers are analyzed with FEA to ensure robust designs

### Closed Impeller (below)

A finite element model of a shrouded impeller

### MSG Cutaway (right)

Unigraphics rendering of a compressor gearbox showing internal bullgear and rotor assemblies

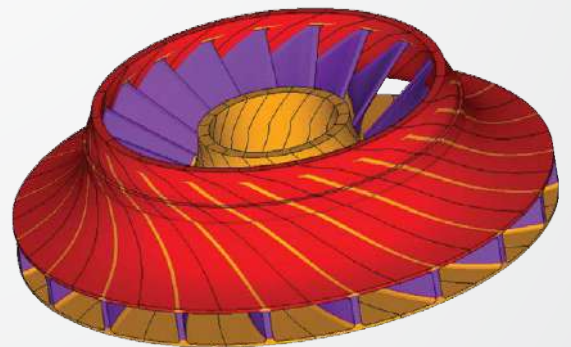



# The Latest Technology in Design Engineering

## 1D, 2D AND 3D CFD SOFTWARE

- Preliminary design – sizing and performance prediction
- Detailed blade shape design
- Analysis using 3D Unsteady Navier-Stokes flow modeling

## Mechanical Analysis

- FEA – stress and resonance calculations
- Rotordynamics – bearing and vibration analysis
- Mechanical design – solid modeling

## Comprehensive Testing

To guarantee performance, all MSG and MSG TURBO-AIR compressor designs are tested for aerodynamic and mechanical performance. Our flexible test stand uses variable speed drives to simulate various mole weight applications. All gas compressors are tested in accordance to ASME PTC-10 Type II standards. Test observation is available upon request. A full set of mechanical and aerodynamic performance data also can be provided.

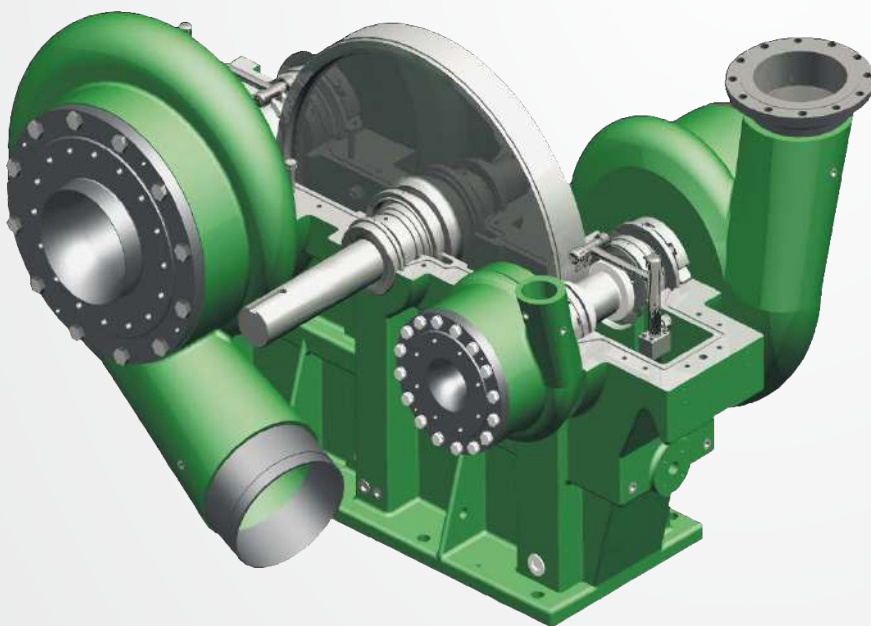

## DEDICATED MANUFACTURING CAPABILITIES

Ingersoll Rand's manufacturing facilities are among the most advanced in the industry, utilizing leading technology, operated by an experienced and skilled workforce. Everything we do at our ISO-9001:2008 facilities is aimed at improving quality and shortening delivery times.

## MANUFACTURING TECHNOLOGY HIGHLIGHTS

- CAD/CAM systems
- Vertical turning centers
- Impeller milling centers – five-axis
- Horizontal boring centers
- Cell manufacturing and work team techniques
- State-of-the-art testing facilities



## Comprehensive Quality

From start to finish, from the factory to the field, in every area, for every employee, quality is the rule. You can expect that from a world-class manufacturer such as Ingersoll Rand. Our objective is to exceed your expectations.



## Our Quality Policy

The key elements of Ingersoll Rand's quality policy are:

- Exceeding customer expectations
- Providing products that equal or exceed industry and government standards
- Providing our customers with the best value
- Focusing on long-term customer satisfaction
- Striving for continuous improvement
- Understanding that quality is everyone's job

## Our Quality Program

### ISO-9001:2008 CERTIFIED QUALITY MANAGEMENT SYSTEM

- Systematic approach to continuous improvement
- 15 trained ISO internal auditors

### ISO-14001:2004 CERTIFIED ENVIRONMENTAL MANAGEMENT SYSTEM

- Dedication to reducing and eliminating waste
- Providing a healthy and safe work environment for all employees
- Meeting or exceeding all environmental, health and safety regulatory requirements

### ISO 8573-1 CLASS 0 CERTIFIED OIL-FREE AIR

- MSG TURBO-AIR centrifugal compressor product line was certified in 2009
- Oil contamination is virtually eliminated by virtue of the compressor design

### SUPPLIER QUALITY MANAGEMENT

- Maintain an approved vendors list
- New suppliers reviewed and evaluated prior to supply chain integration
- Supplier quality performance tracked through the non-conforming product database within our business system
- Periodic supplier performance evaluations

### SIX SIGMA TRAINING

- Addressing customer critical to quality issues
- Process and product improvements that are most beneficial to our customers
- Training in sophisticated problem-solving tools

### CERTIFICATIONS

API, CE, PED, ATEX, China Code Pressure Vessel Certification, GOST, KOSHA, ASME, and more.



## ADDED QUALITY ASSURANCE FROM ADVANCED TESTING FACILITIES

To guarantee performance to both customer and manufacturer specifications, every MSG and MSG TURBO-AIR design is fully tested for aerodynamic and mechanical performance by highly skilled technicians before leaving the factory.

## NINE TEST STANDS

Our test facility in Buffalo, N.Y., includes nine test stands.

- Variable speed drives to simulate actual operating speed requirements of the ASME PTC-10 Type 2 test
- Package testing of machines up to 8200 kW (11,000 hp)
- The test stands are separated into three separate bays, allowing one machine to be set up while another is tested
- Computer controlled cooling towers are used to simulate coolant conditions
- A test stand lubrication system supplies machines with required oil pressure regardless of the test speed, and monitors oil conditions for mechanical loss verification
- Recirculation coolers are available for closed-loop testing

## Testing for Process Gas Compressors

Closed-loop testing with a simulated mole weight gas mixture is standard for process gas compressors. Nitrogen/helium mixtures are used for fuel and lower mole weight gas compressors, and CO<sub>2</sub>/nitrogen mixtures are used for higher mole weight compressors.

## Test Center Computerized Control Room

The test center control room provides computer control of cooling water, input speed and lubricating oil supply.

- Aerodynamic testing through use of finely calibrated pressure and temperature instruments
- Vibration monitoring
- Vibration frequency analysis
- 110% overspeed

## Testing Observation and Documentation

Test observation and performance data are available upon request.

- Documentation can be provided for full operating tests to identify capacity, pressure, temperature and horsepower
- Vibration data for both steady state and coast down operation are recorded to verify rotor critical speed and response



The test center control room provides computer control of cooling water, input speed and lubricating oil supply



Multi-stage carbon monoxide compressor being prepared for closed-loop testing



# Aftermarket Services and Support

How else can we prove our commitment to your total satisfaction? By providing the industry's most comprehensive resource for top-notch aftermarket products, engineering solutions and field service. If you ever have a question or problem, Ingersoll Rand's extensive network of highly skilled technicians and authorized representatives is at your service.





### Installation and Startup

- Machine commissioning services
- Diagnostic and troubleshooting services
- Vibration analysis and trending
- Extended warranty and preventative maintenance programs

### Elite Technical Support

- Installation and operation support
- Our goal is to help keep your unit running

### Technical Training

- Comprehensive training seminars for you and your personnel
- Instructions on a variety of topics, including courses with hands-on training
- Courses can be tailored to your needs at one of our global training centers

### Repair Expertise

- State-of-the-art equipment for turnkey repairs
- Complete documentation packages
- Strategic repair center locations to serve a broad customer base, including Buffalo, N.Y.; Houston, Texas and Milan, Italy.

### Exceptional Parts

- Genuine parts produced in the same facility for more than 60 years
- Extensive inventory in strategic locations around the world, backed by our written warranty
- Cross-checked against engineering records to ensure correctness



# Ingersoll Rand offers more

In addition to our custom-engineered products, we manufacture a complete line of fully packaged centrifugal compressors in a wide range of capacities and power ranges.

## MSG TURBO-AIR Centrifugal Compressors

The revolutionary MSG TURBO-AIR centrifugal compressor offers an advanced, state-of-the-art source of oil-free air for plant air and other applications. Models include:



MSG TURBO-AIR 2000



MSG TURBO-AIR COOLED 2000



MSG TURBO-AIR 2040



MSG TURBO-AIR 3000



MSG TURBO-AIR 6000



MSG TURBO-AIR 6040



MSG TURBO-AIR NX 8000



MSG TURBO-AIR NX 12000



TURBO DRYPAK AND TWINTURBO

**MSG TURBO-AIR 2000** – 93 to 260 kW (125 to 350 hp) and 14.3 to 48.1 m<sup>3</sup>/min (505 to 1700 CFM)

**MSG TURBO-AIR COOLED 2000** – 93 to 260 kW (125 to 350 hp) and 15.6 to 48.1 m<sup>3</sup>/min (550 to 1700 CFM)

**MSG TURBO-AIR 2040** – 373 to 600 kW (500 to 800 hp) and 42 to 51 m<sup>3</sup>/min (1500 to 1800 CFM), up to 42 barg (610 psig)

**MSG TURBO-AIR 3000** – 300 to 600 kW (400 to 800 hp) and 57 to 113 m<sup>3</sup>/min (2000 to 4000 CFM)

**MSG TURBO-AIR 6000** – 600 to 1305 kW (800 to 1750 hp) and 113 to 227 m<sup>3</sup>/min (4000 to 8000 CFM)

**MSG TURBO-AIR 6040** – Up to 1700 kW (2250 hp) and 127 to 167 m<sup>3</sup>/min (4500 to 6000 CFM), up to 42 barg (610 psig)

**MSG TURBO-AIR NX 8000** – 750 to 1700 kW (1000 to 2250 hp) and 135 to 305 m<sup>3</sup>/min (4850 to 10,800 CFM)

**MSG TURBO-AIR NX 12000** – 1120 to 2237 kW (1500 to 3000 hp) and 212 to 430 m<sup>3</sup>/min (7500 to 15,200 CFM)

**TURBO DRYPAK** – 112 to 600 kW (150 to 800 hp) and 15.6 to 113 m<sup>3</sup>/min (550 to 4000 CFM)

**TWINTURBO** – 93 to 3355 kW (125 to 4500 hp) and 30 to 425 m<sup>3</sup>/min (1065 to 15,000 CFM)





Ingersoll Rand (NYSE:IR) advances the quality of life by creating comfortable, sustainable and efficient environments. Our people and our family of brands—including Club Car®, Ingersoll Rand®, Thermo King® and Trane®—work together to enhance the quality and comfort of air in homes and buildings; transport and protect food and perishables; and increase industrial productivity and efficiency. We are a \$13 billion global business committed to a world of sustainable progress and enduring results.



[IngersollRandProducts.com](http://IngersollRandProducts.com)

Distributed by:

Ingersoll Rand, IR, the IR logo, MSG, MSG TURBO-AIR, MSG TURBO-AIR COOLED, TURBO DryPak, TURBO-GAS and MAESTRO are trademarks of Ingersoll Rand, its subsidiaries and/or affiliates. All other trademarks are the property of their respective owners.

Nothing contained on these pages is intended to extend any warranty or representation, expressed or implied, regarding the product described herein. Any such warranties or other terms and conditions of sale of products shall be in accordance with Ingersoll Rand's standard terms and conditions of sale for such products, which are available upon request.

Product improvement is a continuing goal at Ingersoll Rand. Any designs, diagrams, pictures, photographs and specifications contained within this document are for representative purposes only and may include optional scope and/or functionality and are subject to change without notice or obligation.